



moda



Nineteenth in a Series

Finished Quilt: 100"x100"

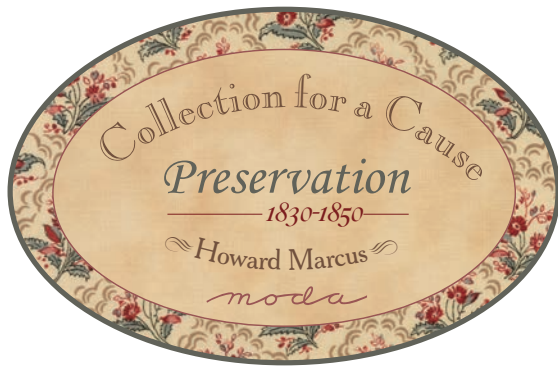

Finished Size: 100" x 100"

Dating to 1830, the original Medallion quilt from England that inspired this Preservation collection features a series of five different pieced borders framing a unique, pre-printed panel that remains uncut. This is a classic style of Northumberland patchwork from the first half of the nineteenth century.

Quilter Basics

Read instructions before beginning a project.

All instructions include a 1/4" seam allowance.

Press as you go. Press seams in one direction.

22" measurement is approximate.

WOF = Width of Fabric

Cutting

Label pieces as they are cut. Include both size and the rounds where they are used.

Panel



Cutting instructions are given in Construction and Assembly on page 6.

Fabric 1



Cut 4-5" x WOF strips for RD 1 squaring border

Cut 4-4" x WOF strips

Subcut 32-4" x 4" background squares for RD 2

Cut 1-4 3/4" x WOF strip

Fold strip in half selvage to selvage and cut 4-Template B pairs for RD 4

Cut 6-1 1/2" x WOF strips for RD 5 border

Cut 5-3 1/2" x WOF strips for RD 6

From 3 strips subcut

36-3 1/2" x 3 1/2" squares for bkgd corners

Fold the remaining strips in half. From *each* strip cut 9 pairs of "peaks" using Template C for star blocks. (36 total)

Cut 1-6 1/2" x WOF strip

Subcut 4-6 1/2" x 6 1/2" squares for RD. 7.

Cut 5-7" x WOF strips

Subcut 24-7" x 7" squares for RD. 7 Half Square Triangles.

moda

Fabric 2



From the fat quarter cut:

2 - 3 1/2" x 22" strips.

Subcut 5 - 3 1/2" x 3 1/2" squares from each strip for RD 2.

1 - 4" x 22" strip.

Subcut 4 - 4" x 4" corner squares and 1 - 3 1/2" x 3 1/2" square for RD 2.

1 - 4" x 22" strip

Subcut 4 - 4" x 4" squares cut once diagonally for RD. 4

From the remainder of the strip cut 1 - 3 1/2" x 3 1/2" square for RD 2.

Fabric 3



Cut 2-3 1/2" x WOF strips.

Fold strips in half selvage to selvage.

Using Template D cut 16 "spike" pairs for the star blocks in RD 6.

From the remainder of the strip cut

1- 3 1/2" x 3 1/2" square for star block center in RD 6.

Cut 1-4" x WOF strips.

Subcut 4-4" x 4" squares; cut once diagonally for RD 4.

From the remainder of the strip cut

7 - 3 1/2" x 3 1/2" squares, 4 for RD 2 and 3 for RD 6

Cutting – cont.

Fabric 4



Cut 4-3"xWOF strips for RD 3.

Cut 1- 7"xWOF strip

Subcut 4- 7"x7" squares for RD 7.

From the remainder of the strip

cut 4 - 3½" x 3½" squares for RD 2.

Fabric 5



From the fat quarter cut:

1 - 3½"x22" strip.

Subcut 4 - 3½" x 3½" squares for RD 2.

1 - 3¼"x22" strip

Subcut 4 - 3¼" x 3¼" squares for RD 4.

1 - 4"x22" strip

Subcut 2 - 4" x 4" squares;

cut once diagonally for RD 4.

Fabric 6

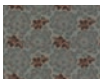

From the fat quarter cut:

1 - 3½"x22" strip and

Subcut 4 - 3½" x 3½" squares for RD 2.

1 - 4"x22" strip

Subcut 4 - 4" x 4" squares; cut once diagonally for RD 4

1- 4¾"x22" strip

Subcut 1-2⅞" x 2⅞" square cut once diagonally for RD 4.

Fold remainder of strip in half selvage to

selvage and cut 1-Template A pair for RD 4.

Fabric 7



From the fat eighth cut:

1 - 3½"x22" strip

Subcut 4 - 3½" x 3½" squares for RD 2.

1 - 4"x22" strip

Subcut 4 - 4" x 4" squares; cut once diagonally for RD 4.

Fabric 8



From the fat eighth cut:

1 - 4"x22" strip

Subcut 4 - 4" x 4" squares; cut once diagonally for RD 4.

Fabric 9



Cut 2 - 3½"xWOF strips.

From one strip cut 7 - 3½" x 3½" squares - 4 for RD 2 and 3 for RD 6.

Fold the second strip in half.

Using Template D cut 12 pairs of "spikes" for RD 6.

Cut 1 - 4"xWOF strip

Subcut 4 - 4" x 4" squares.

Cut once diagonally for RD 4.

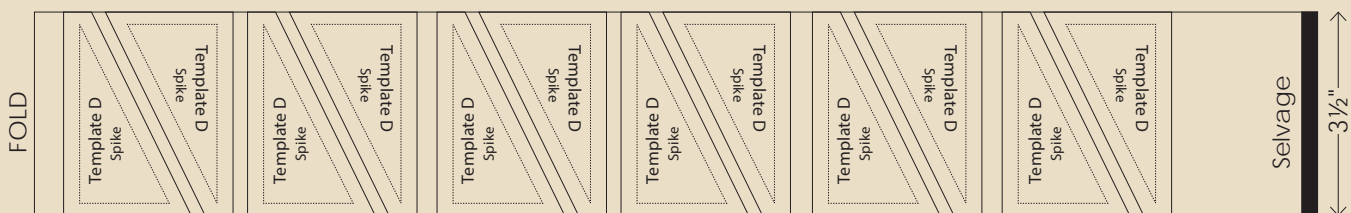

Cutting Diagrams for Templates C and D

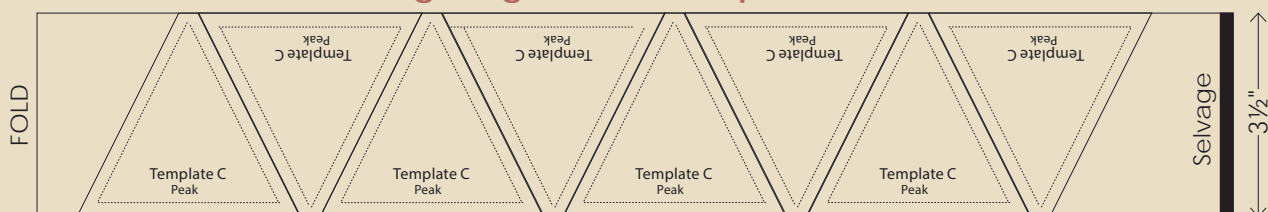

Fabric 10



Cut 2 – 3½" x WOF strips.
 From 1 strip cut 6 – 3½" x 3½" squares – 4 for RD 2 and 2 for RD 6.
 Fold the second strip in half.
 Using Template D cut 8 pairs of “spikes” for RD 6.
 1 – 7" x WOF strip
 Subcut 4 – 7" x 7" squares for RD 7
 From remainder of strip cut 1 – 4¾" x 14" strip.
 Fold strip in half selvage to selvage and cut 1-Template A pair and 1 – 2⅞" square; cut once diagonally for RD. 4.

Fabric 11



From the fat eighth cut:
 1 – 3½" x 22" strip
 Subcut 2 – 3½" x 3½" squares for RD 2.
 1 – 3¼" x 22" strip
 Subcut 4 – 3¼" x 3¼" squares for RD 4.

Fabric 12



From the fat eighth cut:
 1 – 3¼" x 22" strip
 Subcut 4 – 3¼" x 3¼" squares for RD 4.

Fabric 13



Cut 5 – 3½" x WOF strips
 From 1 strip cut 4 – 3½" x 3½" squares for RD 2 and 4 – 3¼" x 3¼" squares for RD 4.
 Fold 2 of the strips in half. Using Template C cut 10 pairs of “peaks” for RD 6. (20 total)
 From the last 2 strips subcut 20 – 3½" x 3½" squares for RD 6.

Fabric 14



Cut 1 – 4" x WOF" strip
 Subcut 4 – 4" x 4" squares; cut once diagonally for RD 4.
 From remainder of strip cut 4 – 3½" x 3½" squares for RD 2.
 Cut 1 – 7" x WOF strip
 Subcut 4 – 7" x 7" squares for RD 7.

Fabric 15



Cut 1 – 3½" x WOF" strip.
 Subcut 4 – 3½" x 3½" squares for RD 2
 From remainder of strip cut 4 – 3¼" x 3¼" squares for RD 4.
 Cut 1 – 7" x WOF strip
 Subcut 4 – 7" x 7" squares for RD 7.

Fabric 16



Cut 1 – 4" x WOF strip
 Subcut 4 – 4" x 4" squares. Cut once diagonally for RD 4. From remainder of strip cut 2 – 3½" x 3½" squares for RD 2.
 Cut 1 – 7" x WOF strip
 Subcut 4 – 7" x 7" squares for RD 7.

Fabric 17

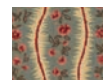

From the fat eighth cut:
 1 – 3½" x 22" strip
 Subcut 4 – 3½" x 3½" squares for RD 2.

Fabric 18



From the fat eighth cut:
 1 – 3½" x 22" strip
 Subcut 2 – 3½" x 3½" squares for RD 2.

Cutting – cont.

Fabric 19



From the fat eighth cut:

1 – 3½"x22" strip

Subcut 2 – 3½"x 3½" squares for RD 2.

1 – 4"x22" strip

Subcut 4 – 4"x 4" squares; cut once diagonally for RD 4.

Fabric 20



From the fat eighth cut:

1 – 3¼"x22" strip

Subcut 4 – 3¼"x 3¼" squares for RD 4.

Fabric 21



From the fat quarter cut:

2 – 7"x22" strips

From each strip subcut 2 – 7"x 7" squares for RD 7

Fabric 22



1 – 4"x22" strip

Subcut 4 – 4"x 4" squares, cut once diagonally for RD 4.

Fabric 23



Cut 3 – 3½"xWOF strips

From 2 strips cut 16 – 3½"x 3½" squares for RD 6 and 4 – 3¼"x 3¼" squares for RD 4.

Fold the remaining strips in half selvage to selvage. Using the enclosed Template C cut 8 pairs of "peaks" from the folded strips for RD 6. (Total 16 "peaks")

Fabric 24



Cut 1–4"xWOF strip

Subcut 2 – 4"x 4" squares. Cut once diagonally for RD 4

From remainder of strip; cut 4 – 3¼"x 3¼" center squares for RD 4

Cut 5–3½"xWOF strips

From 3 strips cut 32 – 3½"x 3½" squares for RD 6.

Fold the remaining 2 strips in half.

Using Template C cut 8 pairs of "peaks" from **each** folded strip for RD 6.

Fabric 25



Cut 2 – 3½"xWOF strips

From 1 strip cut 8 – 3½"x 3½" squares for RD 6 and 4 – 3¼"x 3¼" squares for RD 4.

Fold the remaining strip in half.

Using Template C cut 4 pairs of "peaks" for RD 6. (Total of 8 "peaks")

Fabric 26

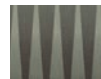

Cut 2 – 3½"xWOF strips

From 1 strip cut 4 – 3½"x 3½" squares for RD 6. Fold the remainder of the strip in half. Using Template D cut 4 pairs of "spikes" for star blocks.

Fold the remaining strip in half selvage to selvage. Using Template D cut 12 pairs of "spikes" for star blocks for RD 6. (Total of 32 "spikes")

moda

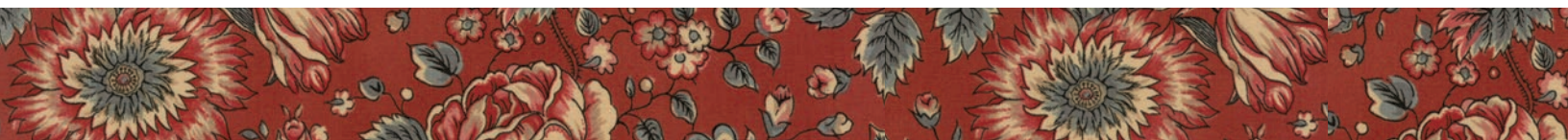

Cutting – cont.

Fabric 27



Cut 3 – 3½" x WOF strips
From 1 strip cut 5 – 3½" x 3½" squares for RD 6.
Fold the remaining 2 strips in half. Using
Template D cut 10 pairs of “spikes”
from **each** folded strip for RD 6.
(Total of 40 “spikes”)

Fabric 28



Cut 3 – 3½" x WOF strips
From 1 strip cut 5 – 3½" x 3½" squares for
RD 6.
Fold the remaining 2 strips in half. Using
Template D cut 10 pairs of “spikes”
from **each** folded strip for RD 6.
(Total of 40 “spikes”)

From the remainder of the fabric cut enough 2½" bias
strips to measure 440" for binding.
If you choose not to use a bias binding, cut 11 – 2½"
strips for binding.

Fabric 29



Cut 6 – 1½" x WOF strips for RD 5.
Cut 3 – 3½" x WOF strips
From 1 strip cut 5 – 3½" x 3½" squares for RD 6.
Fold the remaining 2 strips in half.
Using Template D cut 10 pairs of “spikes”
from **each** folded strip for RD 6.
(Total of 40 “spikes”)

Fabric 30



Cut 6 – 1½" x WOF strips for RD 5.

Fabric 31

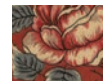

Following directions on page 14;
Fussy cut 4 – 8½" x Length of fabric strips.

Construction and Assembly

This quilt is constructed in Rounds starting with the center panel and working outward through 7 rounds plus the border and binding. As you assemble the blocks and pieces in each round they will be added to the quilt center.

Instructions for each round begin with a list of all cut pieces required for that round. For easy piecing, be sure to sort and label pieces when cutting.

Center and Round 1 Requires:

- 1 Panel
- 4- 5" xWOF strips Fabric (F) 1

Center and Round 1

The center requires four floral motifs from the panel of six.

1. Trim $\frac{1}{4}$ " beyond the outside printed edge of the block of four floral motifs.
2. Measure the length of the center floral motif. Cut 2- 5" xWOF Fabric 1 strips to that measurement (approx. 23").
3. Stitch the cut strips to opposite sides of the center. Press toward border strips.
4. Measure the center from side to side including the just added border strips. Cut the remaining border strips to that measurement. Add to top and bottom of center. Press toward border strips.
5. Find and mark the center of the four motifs. Measure outward from the center $14\frac{1}{4}$ " in all directions. Mark measurement on Fabric 1 border.
6. Use a rotary cutter and ruler to trim center to measure $28\frac{1}{2}$ " x $28\frac{1}{2}$ ". Trim and measure carefully as all rounds to follow are based the $28\frac{1}{2}$ " x $28\frac{1}{2}$ " center square.

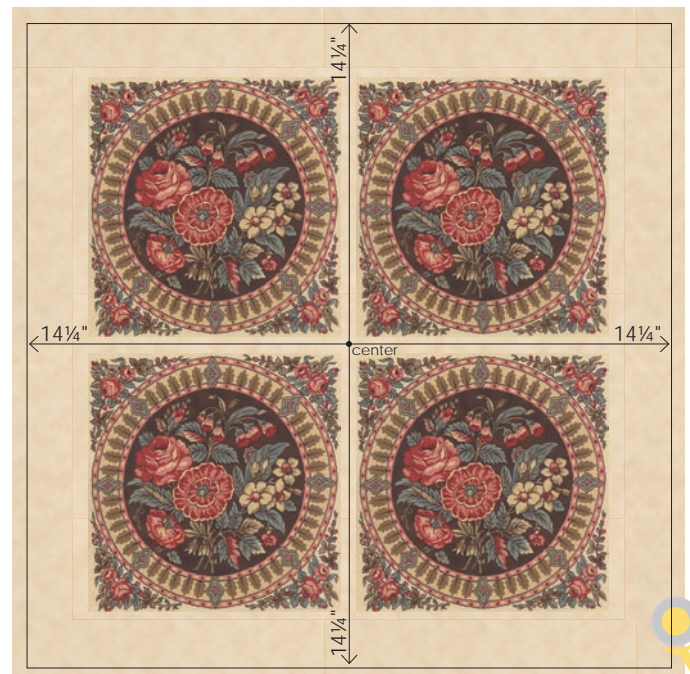

Trim center to measure $28\frac{1}{2}$ " x $28\frac{1}{2}$ "

moda

Making an Easy Corner Triangle Block

Steps below are for 1 block. Repeat steps to make 32 ECT blocks – 16 left and 16 right.

1. Using a mechanical pencil draw a diagonal line on the wrong side of all of the RD 2 3½" print squares.
2. Pair a 4" Fabric 1 background square with 2 marked print squares, according to the diagram below.
3. With right sides together align a print square with the corner of the F1 background square. *Note direction of marked line and striped fabric.*
4. Stitch on marked line. Trim away middle layer of fabric leaving a ¼" seam allowance. Press triangle toward corner. **Do not cut away background fabric.**
5. Repeat Steps 3 & 4 with the second print square.

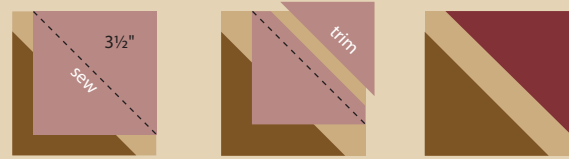
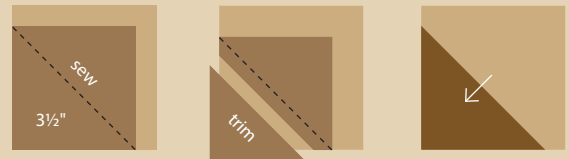

Make 16
Left



Make 16
Right

Make a total of 32 ECT blocks. Make 16 with a left slant of the background stripe and 16 with a right slant.

{See chart below for fabric placement.}

Round 2 Requires:

- 32 – 4" squares F1
- 4 – 4" corner squares F2
- 12 – 3½" squares F2
- 4 – 3½" squares from F3, 4, 5, 6, 7, 9, F10,13,14,15 and 17
- 2 – 3½" squares from F11,16,18 and 19

Round 2 Zig Zag Border

This border is constructed using easy corner triangles (ECT) on a Fabric 1 background square. In order to create the matching larger triangle units which are made when blocks are joined, layout each row before beginning to sew. *Note: Each row begins and ends with the same fabric as the corner squares (F2). See the diagram below for color placement or create your own arrangement. Each row includes 4 left blocks and 4 right blocks.*

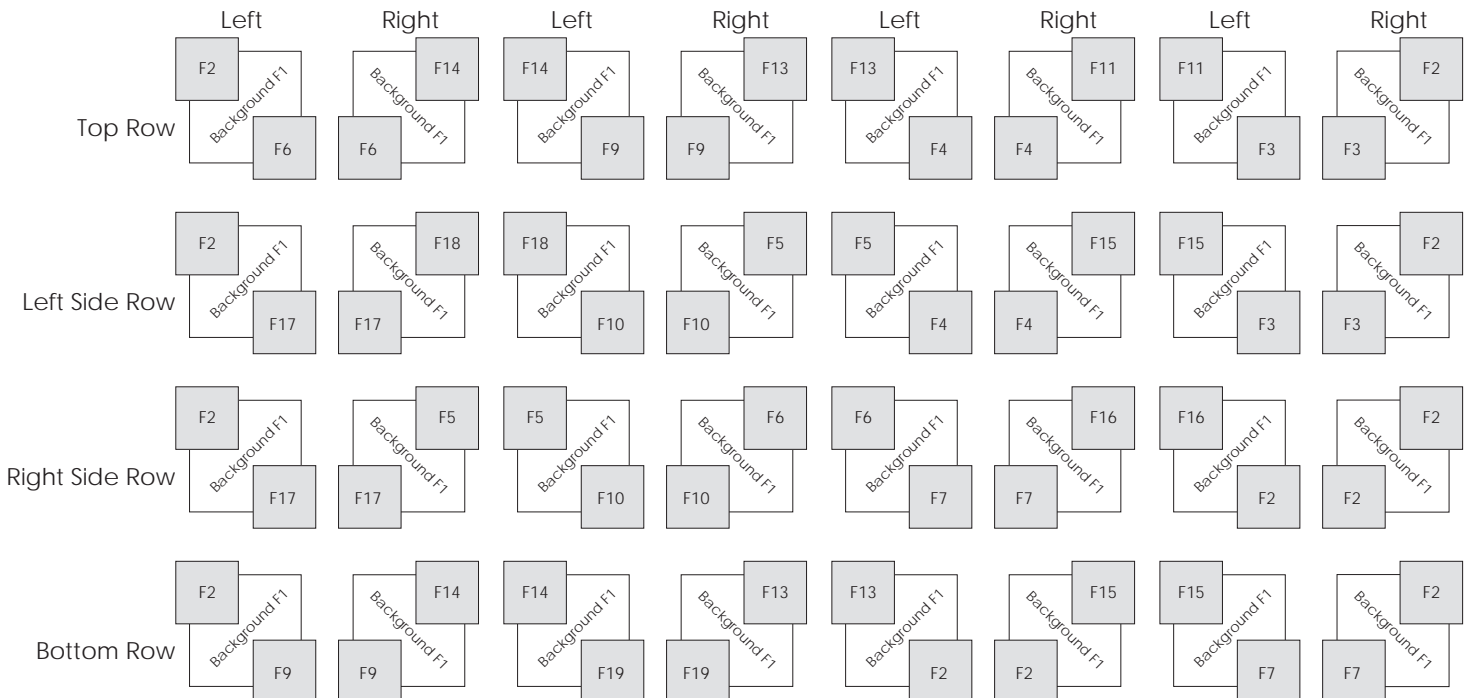

Construction and Assembly – cont.

Round 2 cont.

Assemble Zig Zag Borders

Arrange the blocks into 4 rows of 8 blocks as shown, matching fabrics. Sew and press seams in one direction. Rows should measure 4"x28½" with seams. *Refer to quilt image.* Stitch 2 rows to opposite sides of quilt center. Press seams toward cream border.

Add 4" F2 squares to opposite ends of remaining 2 rows. Press seam toward corner square. Add borders to top and bottom of quilt center.

Quilt top should measure 35½"x35½" with seams.

Top Row



Left Side Row



Right Side Row



Bottom Row



moda

Round 3 Requires:

4- 3" xWOF strips F4

Round 3 Borders

1. Cut – 2-3" xWOF strips to measure 3"x35½". Stitch to opposite sides of the quilt center. Press toward print border.
2. Measure quilt from side to side through the center including the borders. Cut the 2 remaining border strips to that measurement and stitch to the top and bottom of quilt center. Press toward print border.

Quilt top should measure 40½"x40½" with seams.



Construction and Assembly – cont.

Round 4 Requires:

- 4-Template B pairs F1
- 1-Template A pair F6, 10
- 4-4" squares cut once diagonally
F2, 3, 6, 7, 8, 9, 14, 19 and 22
- 2-4" squares cut once diagonally
F5 and 24
- 1-2 $\frac{7}{8}$ " square cut once diagonally
F6 and 10
- 4 - 3 $\frac{1}{4}$ " squares F5, 11, 12, 13, 15, 20,
F 23, 24 and 25

Round 4 Hour Glass Border

Piecing the Hourglass Border

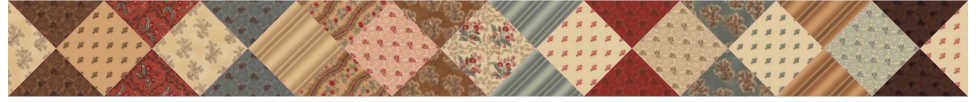

1. Lay out the triangles and squares as shown in diagram.

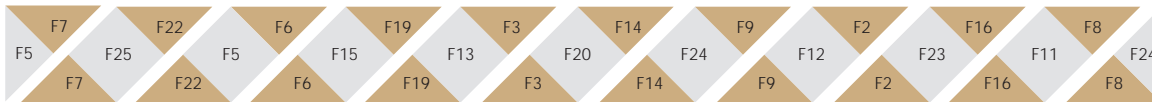
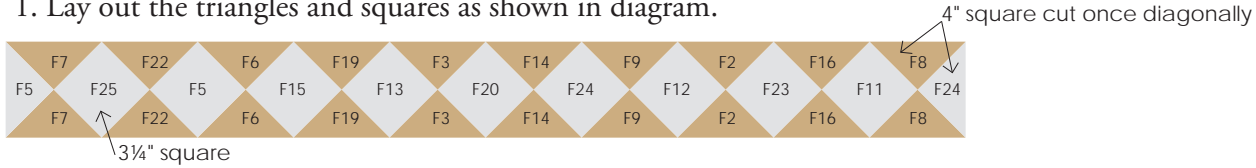

Refer to diagram above for fabric placement. Piece 4 identical border units.

2. Select a 3 $\frac{1}{4}$ " square and 2 triangles. Align square edge of triangle with the square, as shown. Triangles are slightly over sized and will extend beyond the edge of the square. Press toward center square. See diagram.
3. Continue sewing triangles and squares until you have 9 units.

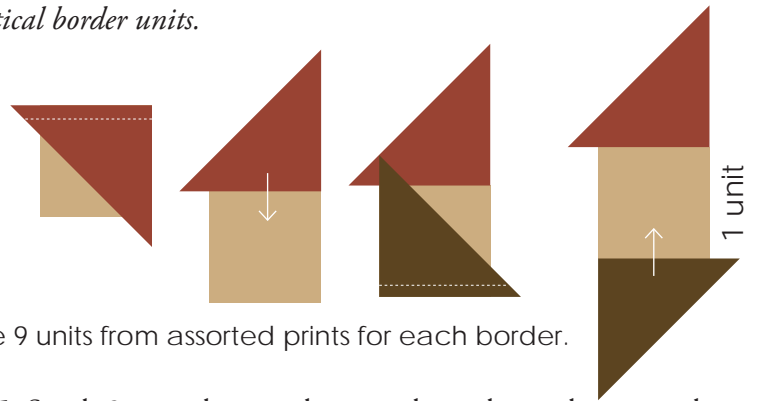

Make 9 units from assorted prints for each border.

4. With right sides together align edge of the units, as shown, so that the seam allowances butt together. Stitch using a scant $\frac{1}{4}$ " seam. Trim away triangle points. Press toward arrow.

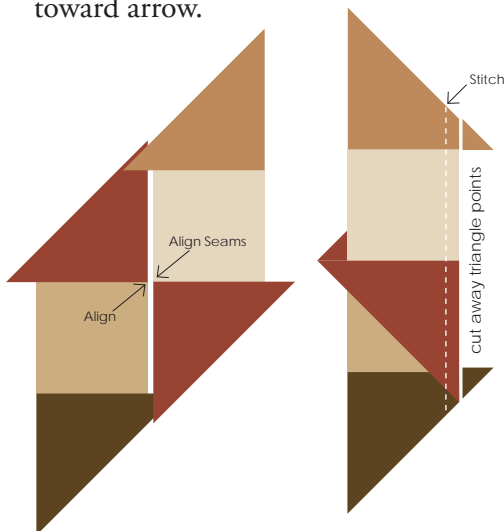

5. Stitch 2 triangles together matching short edges to make 2 end caps for each border. Press toward arrow. Add to opposite ends of each border making sure the light triangle faces the pieced corner block. Press toward end caps. Make a total of 8 end caps.

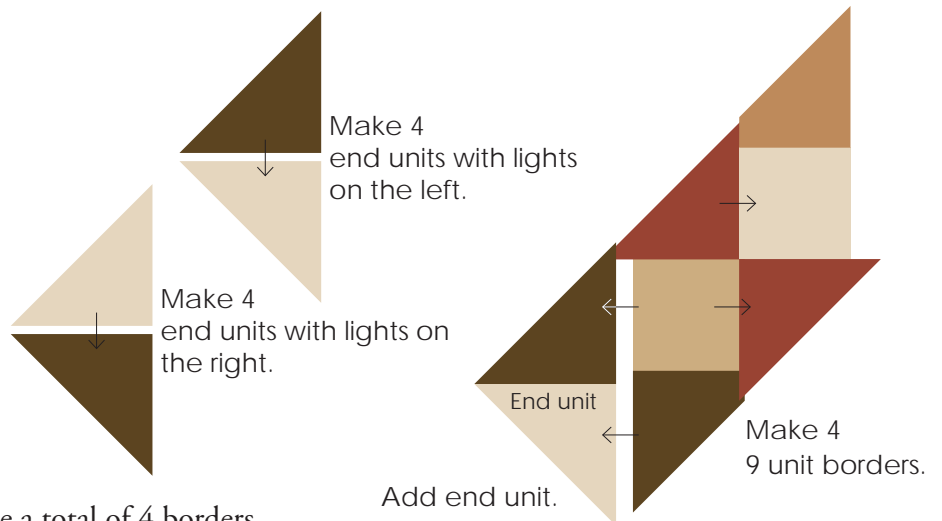

6. Repeat Steps 2-5 to create a total of 4 borders.

Each border should measure 4 $\frac{1}{2}$ " x 40 $\frac{1}{2}$ " with seams.

Piecing Corner Blocks

1. Stitch a pair of Template B Fabric 1 pieces to opposite sides of the Template A print cone. Press seams toward Fabric 1 pieces. See diagram.
2. Center and add the matching $2\frac{7}{8}$ " triangle to top of the cone to complete the block. Press seam toward triangle. Corner block should measure $4\frac{1}{2}$ "x $4\frac{1}{2}$ " with seams.
3. Repeat Steps 1 & 2 to make total of 4 corner blocks – 2 with Fabric 6 cones and 2 with Fabric 10 cones.

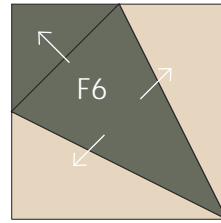
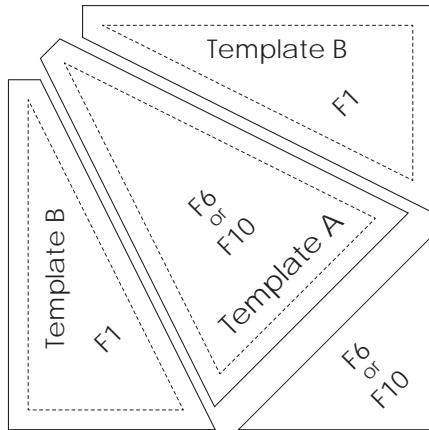

Make 2

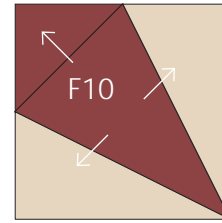

Make 2

Block should measure $4\frac{1}{2}$ "x $4\frac{1}{2}$ " with seams.

4. Add pieced hourglass border to opposite sides of the quilt top. Press seams toward center.
5. Add a red and blue corner block to opposite ends of remaining borders. Press toward the corner block. Refer to quilt image for color placement. Stitch borders to top and bottom of quilt center.

Quilt top should measure $48\frac{1}{2}$ "x $48\frac{1}{2}$ " with seams.

Round 5 Requires:

6 - $1\frac{1}{2}$ " x WOF strips each F1, 29 and 30

Round 5 Border

Corner Blocks – Make 4

From 1 strip of fabrics F1, F29 and F30 cut the following pieces:

F1: 4 – $1\frac{1}{2}$ "x $1\frac{1}{2}$ " squares

F29: 4 – $1\frac{1}{2}$ "x $2\frac{1}{2}$ " rectangles and 4 – $1\frac{1}{2}$ "x $1\frac{1}{2}$ " squares

F30 : 4 – $1\frac{1}{2}$ "x $2\frac{1}{2}$ " and 4 – $1\frac{1}{2}$ "x $3\frac{1}{2}$ " rectangles

Follow stitching and pressing diagram for Steps 1, 2 & 3 on the right to make four nine patch corner blocks. Each block should measure $3\frac{1}{2}$ "x $3\frac{1}{2}$ " with seams.

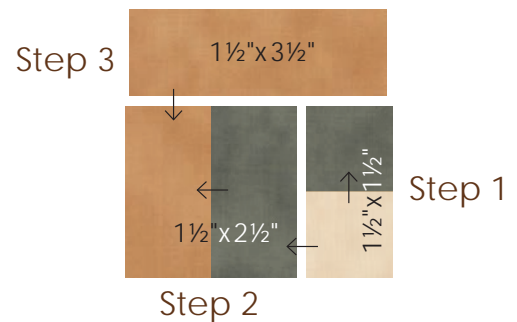

Make 4

Block should measure $3\frac{1}{2}$ "x $3\frac{1}{2}$ " with seams.

moda

Construction and Assembly – cont. _____

Round 5 Border- cont.

Assemble Borders

1. Cut **one** of the 1½" x WOF strips of Fabric 1 in half at the fold.
2. Join 2 strips plus the half strip of Fabric 1 together end to end. Press seams open.
Repeat with the remaining 2½ strips of the same color.
3. Repeat Steps 1 and 2 with the remaining two colors Fabrics 29 and 30.
4. Select three pieced strips – one of each color. Stitch together in the following order F30, F29 and F1.
Press seams away from Fabric 1. Repeat with the second set of 3.
5. From each pieced strip set cut 2 – 3½" x 48½" border strips for a total of 4.
6. Stitch a border to opposite sides of quilt top. The Fabric 1 strip should be next to the quilt center.
See quilt image. Press toward border strip.
7. Add corner blocks to opposite ends of the remaining border strips, as shown below. Press toward border.
8. Stitch border strips to top and bottom of quilt top and press toward the border strips to complete Round 5.

Quilt top should measure 54½" x 54½" with seams.



Step 7: Add corner blocks to opposite ends of the remaining border strips. Press toward border.

moda

Construction and Assembly – cont.

Round 6 Requires:

- 10-Template C pairs F13
- 18-Template C pairs F1
- 16-Template C pairs F24
- 8-Template C pairs F23
- 4-Template C pairs F25
- 20-Template D pairs F27, 28 and 29
- 16-Template D pairs F3 and 26
- 12-Template D pairs F9
- 8-Template D pairs F10
- 36 – 3½" squares F1
- 32 – 3½" squares F24
- 20 – 3½" squares F13
- 16 – 3½" squares F23
- 8 – 3½" squares F25
- 5 – 3½" squares F27, 28 and 29
- 4 – 3½" squares F3 and 26
- 3 – 3½" squares F9
- 2 – 3½" squares F10

Round 6 Star Border

Steps below are for 1 block. Repeat steps to make 28 star blocks.

1. Stitch two matching Template D “spikes” to opposite sides of a background Template C “peak”. Press seams toward background. Repeat to make 4 matching units. Unit should measure 3½"x3½" with seams.

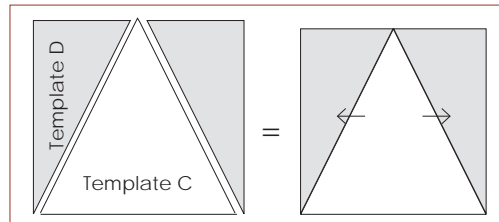

Unit should measure 3½"x 3½" with seams
Make 4 matching units.

2. Lay out pieced units, center square and background squares to make a star block.

3. Stitch units to make 3 rows of 3. Join rows to make the star block. Press toward arrows. Block should measure 9½"x9½" with seams.

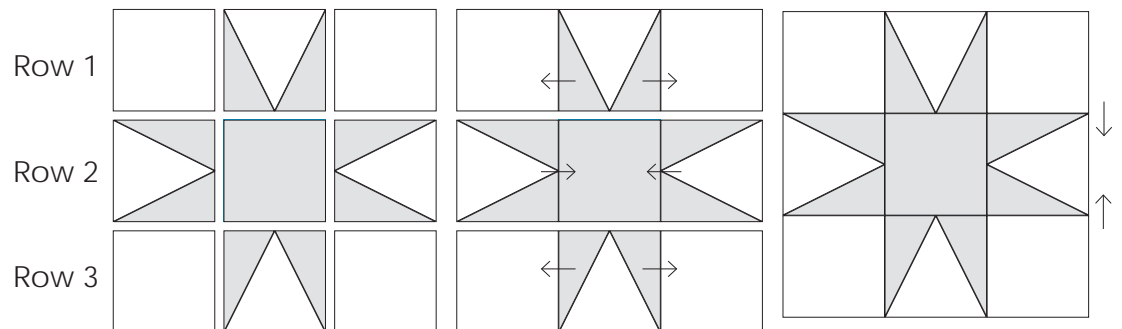

Star block should measure 9½"x 9½" with seams

Star #	Star Fab.	Bkgd	Make
1	F28	F13	5
2	F29	F24	5
3	F27	F1	5
4	F26	F1	4
5	F3	F23	4
6	F9	F24	3
7	F10	F25	2

4. Refer to quilt image for block placement or choose your own arrangement. Piece 2 rows of eight star blocks and 2 rows of six blocks. The eight block rows should measure 9½"x72½" with seams. Six block rows should measure 9½"x54½" with seams.

5. Stitch the shorter rows to opposite sides of quilt center. Press toward quilt center. Add longer rows to top and bottom of quilt and press toward the center.

Quilt top should measure 72½"x72½" with seams.

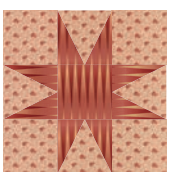

Star 1
Make 5

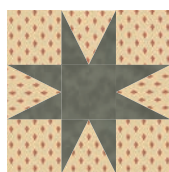

Star 2
Make 5

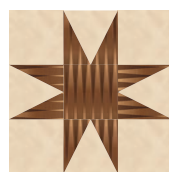

Star 3
Make 5

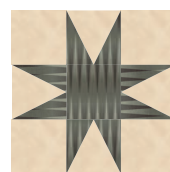

Star 4
Make 4



Star 5
Make 4

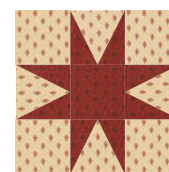

Star 6
Make 3

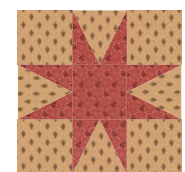

Star 7
Make 2

Construction and Assembly – cont.

Round 7 Requires:

24 – 7" x 7" squares F1
4 – 6½" x 6½" squares F1
4 – 7" x 7" squares each F4, 10, 14, 15,
16 and 21

Round 7 Half Square Triangle Border

1. Using a mechanical pencil draw a diagonal line on the wrong side of 24 – Fabric 1- 7" squares .
2. With right sides together align edges to pair each of the marked Fabric 1 squares with a 7" x 7" print square. Because most of the fabrics are directional, stitch 2 pairs of blocks with diagonal line to the left and 2 pairs with diagonal line to the right.
See diagram.
3. Stitch a scant ¼" on opposite sides of the marked line.
4. Using a ruler and rotary cutter cut stitched block on marked line to yield 2 half square triangle (HST) blocks. Press toward print.
5. Trim and square HST blocks to measure 6½" x 6½" with seams. Make a total of 48 HST blocks.
6. Refer to quilt image for block placement. *Note direction* of HSTs and stitch 4 rows of 12 blocks. Row should measure 6½" x 72½" with seams.
7. Stitch 2 rows to opposite sides of quilt top. Print triangles should point outward. Press seams toward triangle border.
8. Add the Fabric 1- 6½" squares to opposite ends of remaining triangle rows. Press toward triangles. Stitch rows to top and bottom of quilt top.
Quilt top should measure 84½" x 84½" with seams.

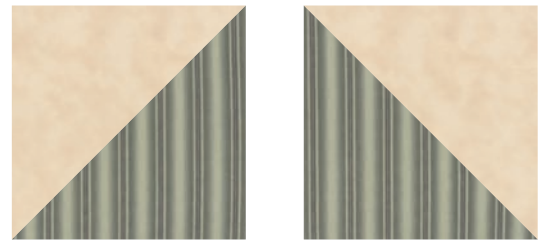
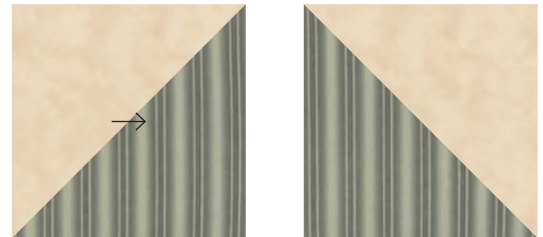
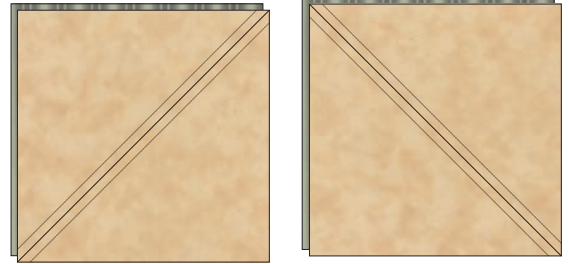

Make 4 rows. Each row should measure 6½" x 72½" with seams

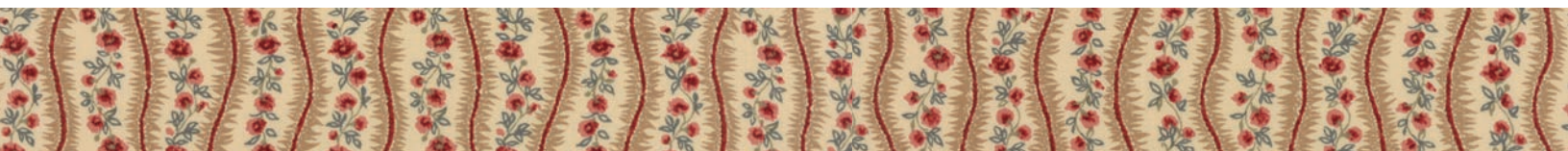

Outer Border and Finishing

Outer Border

1. Open Fabric 31 to full width with the tan printed selvage on the left, move slightly to the right and select a “starting” motif. Clip fabric.
2. Measure over $8\frac{1}{2}$ " and clip fabric again. Continue to the right approximately $2\frac{3}{4}$ " to find a repeat of the “starting” motif and clip again. Repeat to mark 4 – $8\frac{1}{2}$ " borders. *See diagram.*
3. Tear the clipped fabric down the lengthwise grain to yield 4– $8\frac{1}{2}$ "x108" border strips.



HINT: *Since there is a little extra length in the border strips, you might wish to audition each border for the best placement of the motifs before cutting the final border lengths.*

4. Measure quilt top from top to bottom through the center. Cut 2 borders from the prepared border strips to that measurement. Add prepared strips to opposite sides of quilt. Press seams toward border.
5. Measure quilt top from side to side through the center including the borders. Cut 2 borders from remaining prepared border strips to that measurement. Add prepared strips to top and bottom of quilt. Press seams toward border.

Quilt top should measure $100\frac{1}{2}$ "x $100\frac{1}{2}$ " with seams.

Finishing

1. Using a diagonal seam, join binding strips end to end. Press seams open. Fold prepared strip in half wrong sides together and press to make the binding.
2. Layer, Quilt, and Bind

moda

Templates

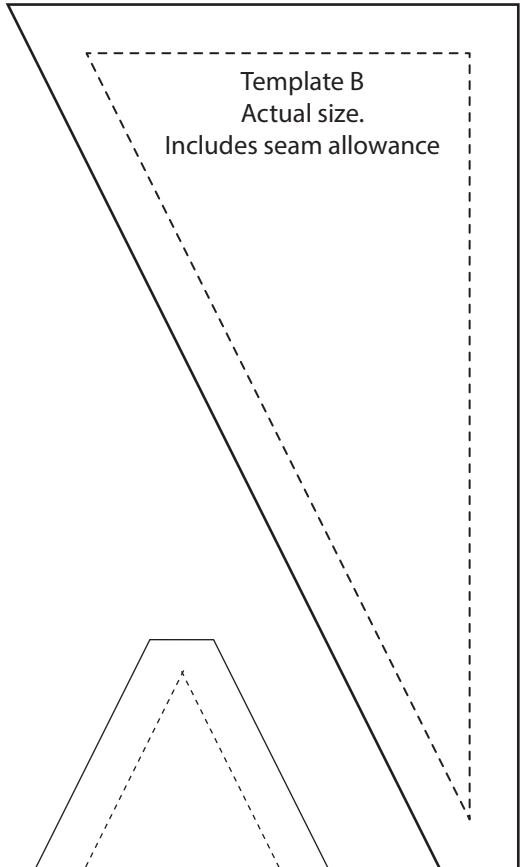
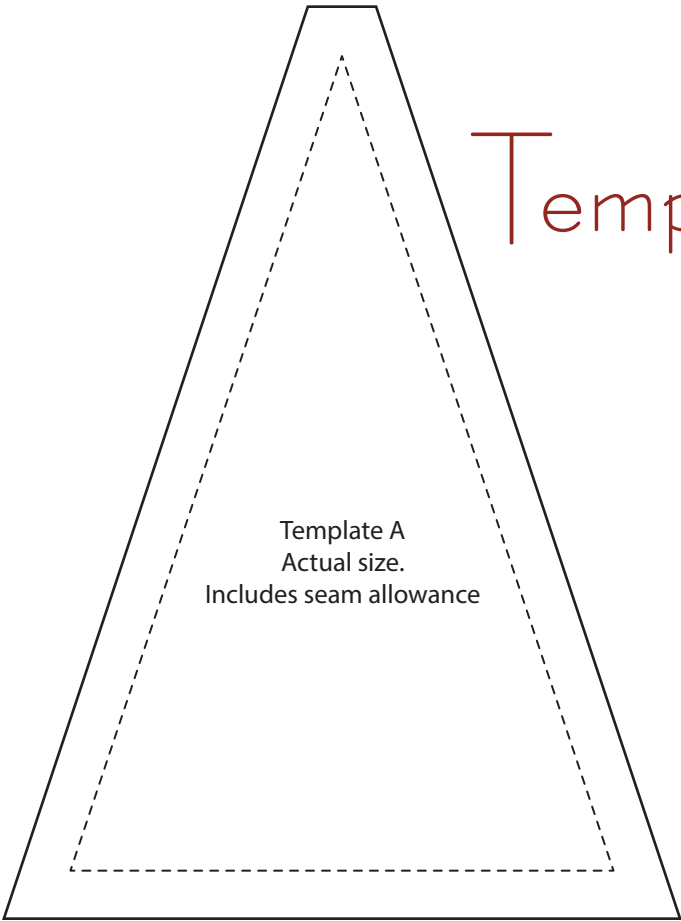

Collection for a Cause
Preservation
1830-1850

Howard Marcus

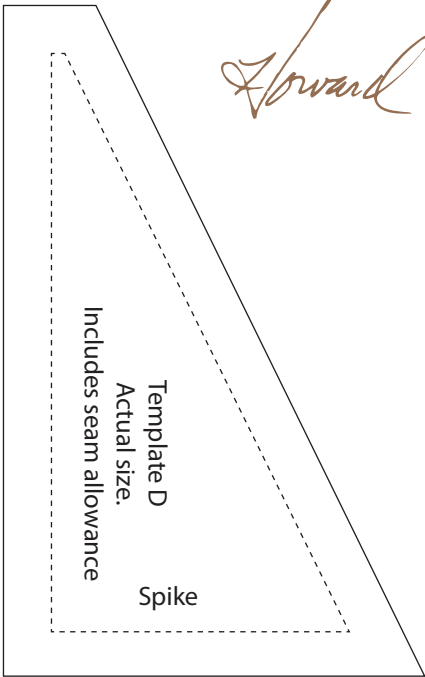

moda



Supporting the Cause

Collection for a Cause – Preservation is the 19th in the series, and will benefit the International Quilt Study Center & Museum in Lincoln, Nebraska.

Created to be a dynamic learning center for teachers, scholars, artists and quilters, the Study Center houses a comprehensive and accessible collection of quilts, related textiles and documents for the purpose of study, insight and inspiration.

Fabric Requirements

Finished Size: 100" x 100"

Fabric 1 3¼ yds 461171-61 Background	Fabric 2 FO 46236-11	Fabric 3 ½ yd 46236-16	Fabric 4 ⅝ yd 46236-14	Fabric 5 FO 46236-13	Fabric 6 FO 46234-11
Fabric 7 F8 46234-14	Fabric 8 F8 46234-15	Fabric 9 ½ yd 46234-16	Fabric 10 ½ yd 46234-17	Fabric 11 F8 46234-18	Fabric 12 F8 46234-19
Fabric 13 ⅝ yd 46234-20	Fabric 14 ½ yd 46238-11	Fabric 15 ½ yd 46238-12	Fabric 16 ½ yd 46238-14	Fabric 17 F8 46233-12	Fabric 18 F8 46233-13
Fabric 19 F8 46233-14	Fabric 20 F8 46235-12	Fabric 21 FO 46235-13	Fabric 22 F8 46235-16	Fabric 23 ½ yd 46237-12	Fabric 24 ⅝ yd 46237-14
Fabric 25 ¼ yd 46237-16	Fabric 26 ¼ yd 46232-11	Fabric 27 ½ yd 46232-14	Fabric 28 1¼ yds 46232-17 Blocks/Binding	Fabric 29 ⅝ yd 461171-60	Fabric 30 ½ yd 461171-62
Fabric 31 3 yds 46231-16 Outer Border	1 Panel 46230-12				



• Skill Level: Intermediate



MODAFABRICS.COM

PS46230 — SUGGESTED RETAIL \$10.00

• Kit yardage may vary from amounts given on this project sheet.